

## Dual Band 2.44 and 5.5 GHz RF Chip Antenna

- 2.4 – 2.48 and 5.15 – 5.85 GHz pass band
- IEEE 802.11, Wi-Fi, WLAN, IoT
- Mini SMD, EIA 0603
- Corner mount
- RoHS compliant and AEC-Q200 Qualified available

Johanson Technology, Inc. (JTI) miniature RF ceramic chip antennas are made using Low Temperature Co-fired Ceramic (LTCC) technology which has the ability to embed low and high dielectric constants inside our antenna. This enables our components to have high detuning resilience and stability over extreme temperatures (~2ppm).

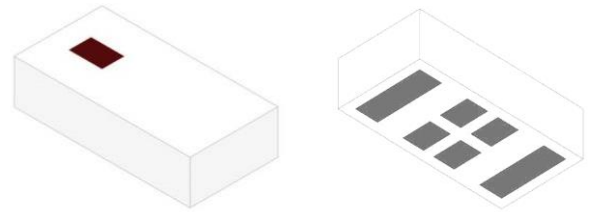

Recommended mounting locations for this antenna

PCB Corner



### General Specifications<sup>1 2</sup>

Passband Frequency (MHz)	2400 - 2480	5150 - 5850
Impedance ( $\Omega$ )	50	50
Return Loss (dB)	7.2 Typ. (2.7 Min.)	9.5 Typ. (3.9 Min.)
Peak Gain (dBi)	1.0 Typ.	4.0 Typ.
Average Gain (dBi)	-3.5 Typ.	-2.5 Typ.
Average Radiated Efficiency (%) – EVB1	53	82
Average Radiated Efficiency (%) – EVB2	58	72

### Maximum Ratings

Power Capacity (W)	2 Max. (CW)
Operating Temperature ( $^{\circ}\text{C}$ )	-40 to +85
Recommended Storage Conditions post-installation ( $^{\circ}\text{C}$ )	-40 to +85
Recommended Storage Conditions and Period for Unused T&R Product	45% - 75% RH +5 to +35 $^{\circ}\text{C}$ 18 Months Max.

<sup>1</sup> Typical value represents average measurement at 25 $^{\circ}\text{C}$ . Min./Max. values represent measurements over specified operating temperature.

<sup>2</sup> Peak and Average Gains measured on Johanson's evaluation board P/N 2450AD14A5500001CE2.

**Mechanical Dimensions**

	Inches			Millimeters		
<b>L</b>	0.063	±	0.004	1.60	±	0.10
<b>W</b>	0.031	±	0.004	0.80	±	0.10
<b>T</b>	0.016		Max.	0.40		Max.
<b>a</b>	0.003	±	0.004	0.086	±	0.10
<b>b</b>	0.008		Min.	0.208		Min.
<b>c</b>	0.008	±	0.001	0.20	±	0.03
<b>d</b>	0.003	±	0.001	0.085	±	0.03
<b>e</b>	0.008	±	0.002	0.215	±	0.05
<b>f</b>	0.010	±	0.002	0.25	±	0.05
<b>g</b>	0.006		Min.	0.15		Min.
<b>h</b>	0.008	±	0.001	0.20	±	0.03

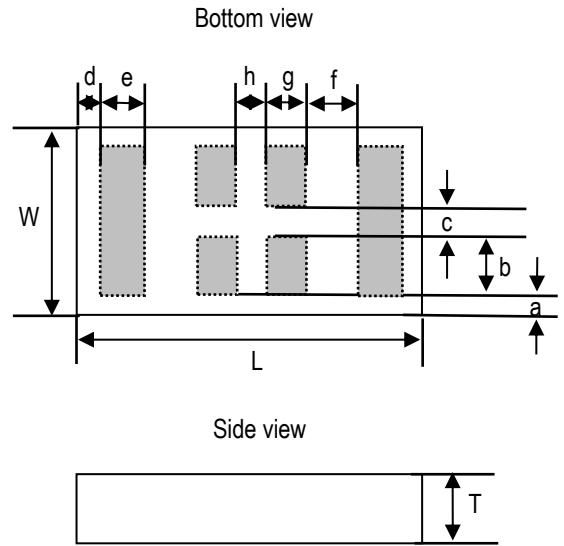

**Terminal Configuration<sup>3 4</sup>**

Pin Number	Function	
	Scenario 1	Scenario 2
1	GND	GND
2	Feed	NC
3	NC	NC
4	NC	Feed

<sup>3</sup> Terminals 2 and 4 have two pads each, and both terminals can function as Feed. NC ("No Connect") terminals must be soldered down to the landing pad for proper operation.

<sup>4</sup> The termination type is Nickel Tin. Go to: <https://www.johansontechnology.com/ipcsoldering-profile> for Typical Soldering Profile.

**Evaluation Board and Recommended Mounting Configuration 1 (P/N 2450AD14A5500001CE1) – 70x40mm (Scenario 1)**

All units in mm

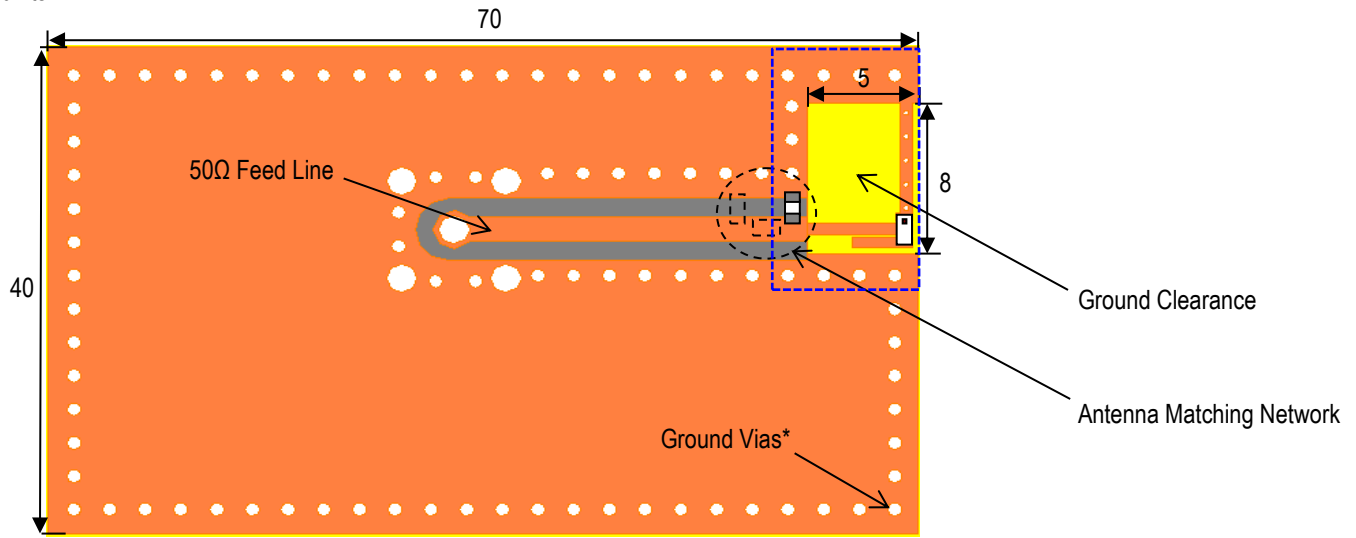

Top View

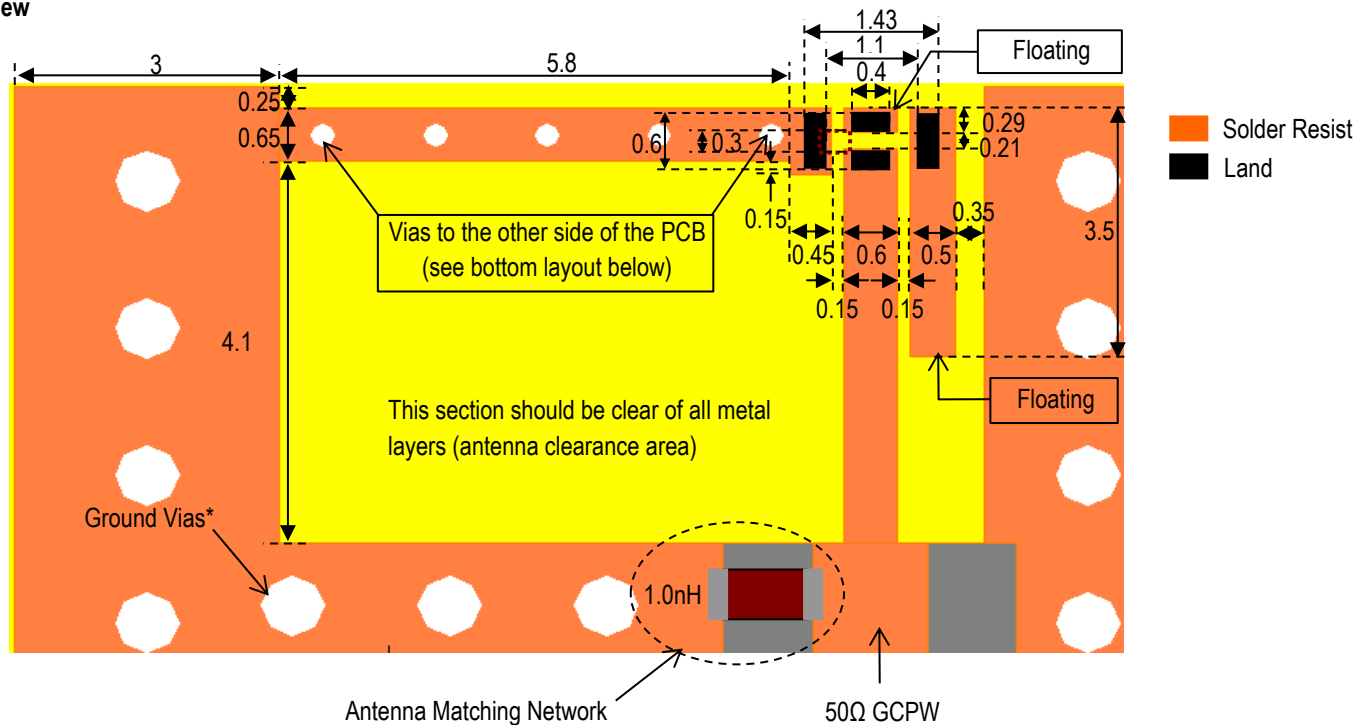

JTI P/Ns for Matching Network<sup>5</sup>

Inductor (1.0nH): LRC0402CS1N0GV001T

\*Note: Ground Vias are highly recommended to have better antenna efficiency.

<sup>5</sup> It is recommended that the designer leave available slots for a "pi" (or shunt-series-shunt) network. The antenna matching network values above are used when the antenna is mounted on Johanson's evaluation board. The optimal matching values will vary depending on the layout, thickness, material, etc. Go to: <https://www.johansontechnology.com/tuning> for more information.

**Bottom View**

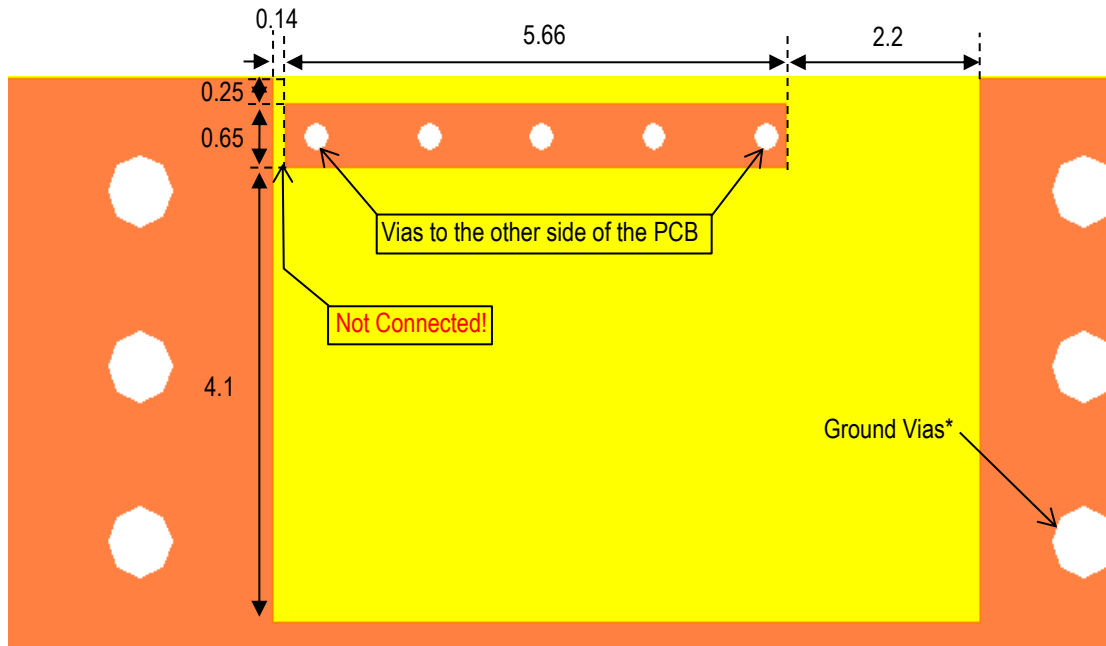

\*Note: Ground Vias are highly recommended to have better antenna efficiency.

If you'd like the CAD PCB layout or have any questions,  
contact our application engineers at <https://www.johansontechnology.com/ask-a-question>

**Evaluation Board Typical Return Loss Measurement (P/N 2450AD14A5500001CE1)**

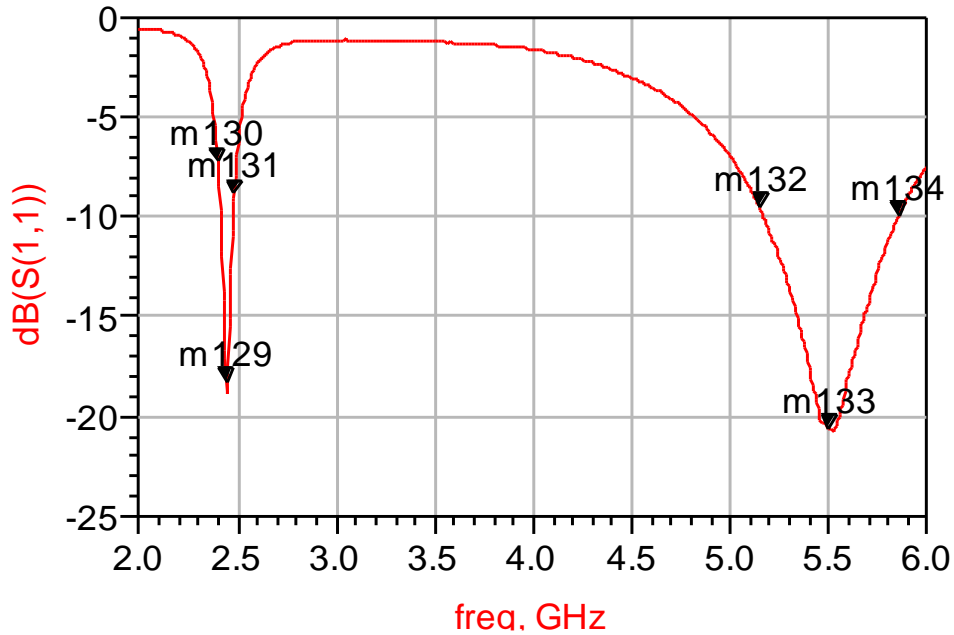

m130 freq=2.400GHz dB(S(1,1))=-7.250	m129 freq=2.442GHz dB(S(1,1))=-18.254	m131 freq=2.484GHz dB(S(1,1))=-8.854
m132 freq=5.150GHz dB(S(1,1))=-9.557	m133 freq=5.500GHz dB(S(1,1))=-20.673	m134 freq=5.850GHz dB(S(1,1))=-10.013

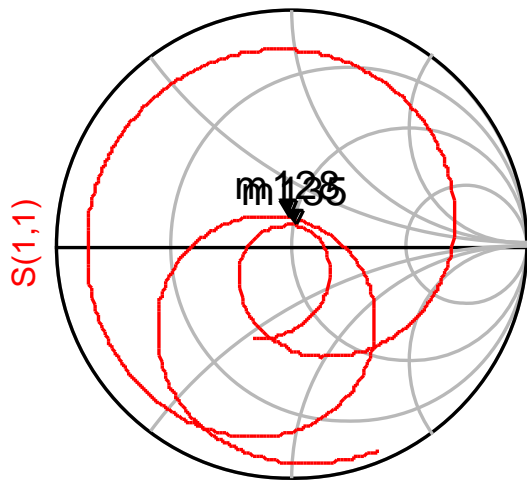

m128 freq=2.442GHz S(1,1)=0.122 / 95.014 impedance = 47.527 + j11.753
m135 freq=5.500GHz S(1,1)=0.093 / 81.368 impedance = 50.543 + j9.329

freq (2.000GHz to 6.000GHz)

**Evaluation Board Typical 2D Radiation Patterns (P/N 2450AD14A550001CE1)**

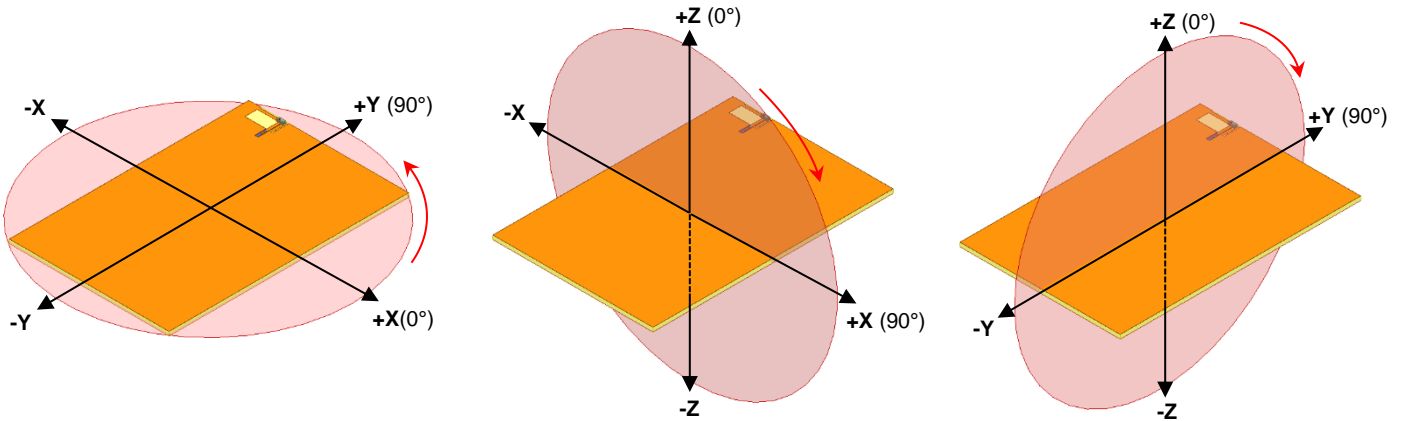

**@2.44GHz Band**

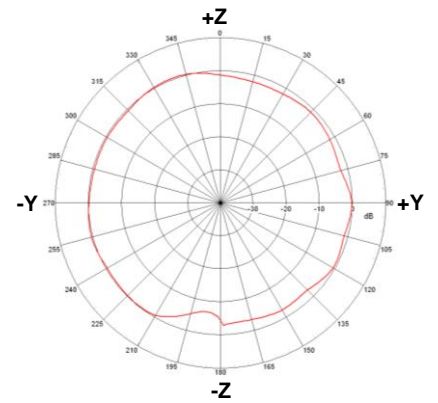
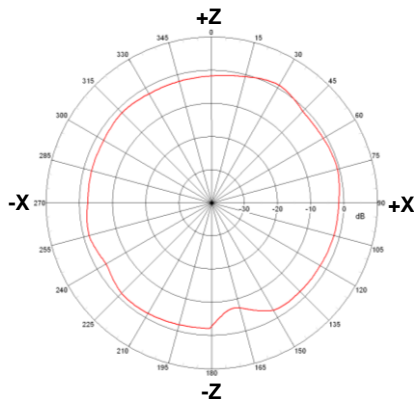
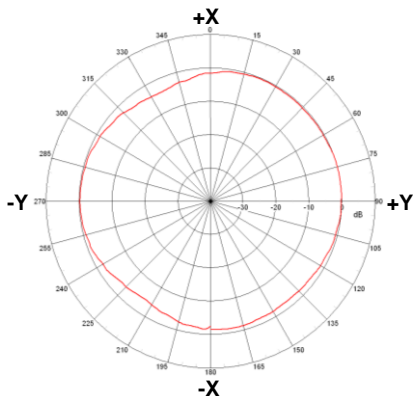

**@5.5GHz Band**

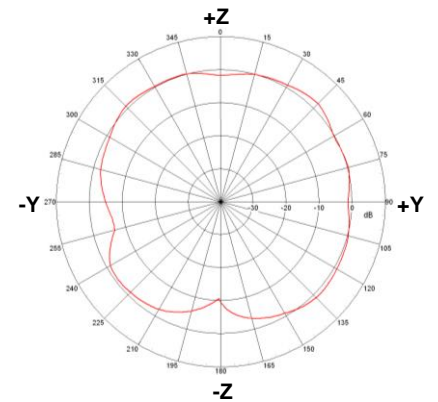
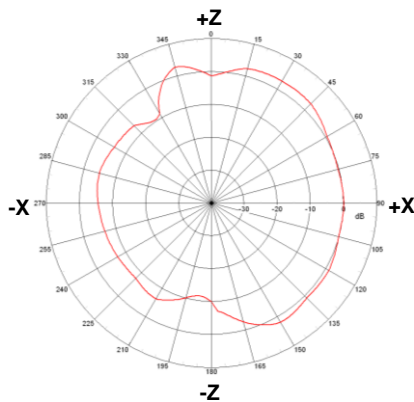
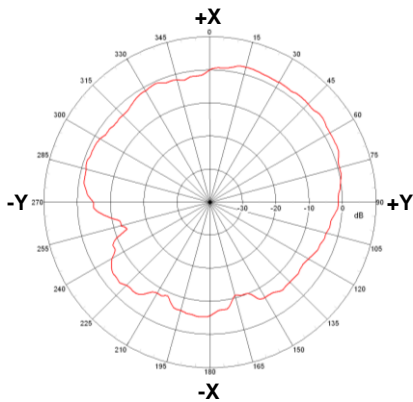

**Evaluation Board and Recommended Mounting Configuration 2 (P/N 2450AD14A5500001CE2)<sup>6</sup> – 120x65mm (Scenario 1)**

All units in mm

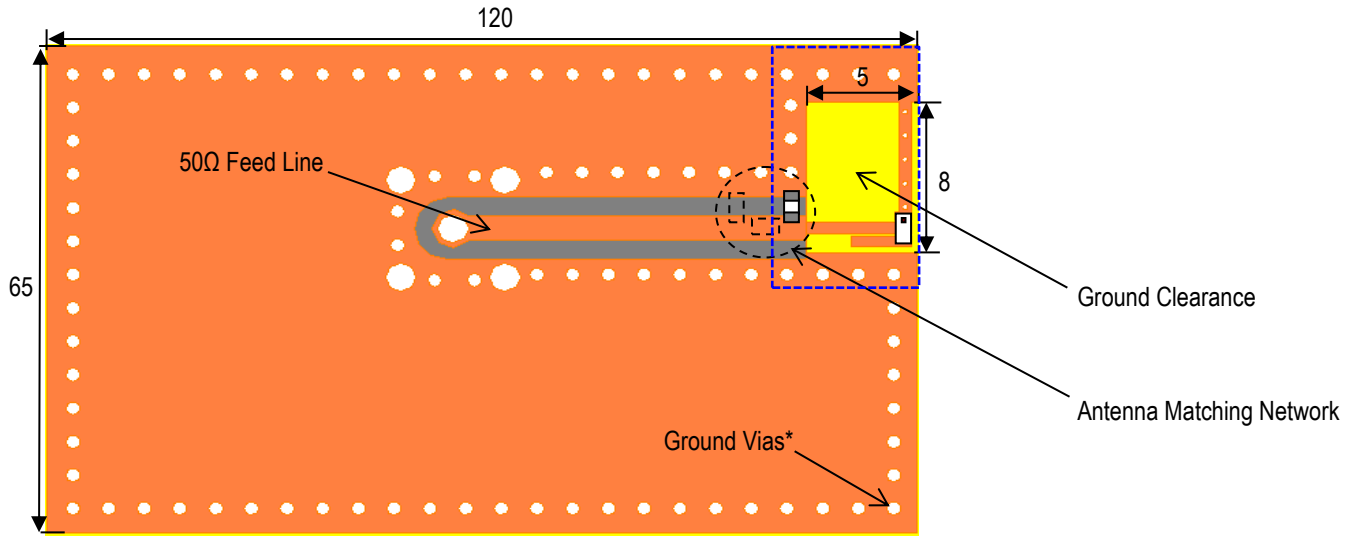

\*Note: Ground Vias are highly recommended to have better antenna efficiency.

If you'd like the CAD PCB layout or have any questions,  
contact our application engineers at <https://www.johansontechnology.com/ask-a-question>

<sup>6</sup> The PCB Layout of evaluation board 2 is the same as evaluation board 1, including the matching network. The only difference is the overall L&W of the PCB.

**Evaluation Board Typical Return Loss Measurement (P/N 2450AD14A5500001CE2)**

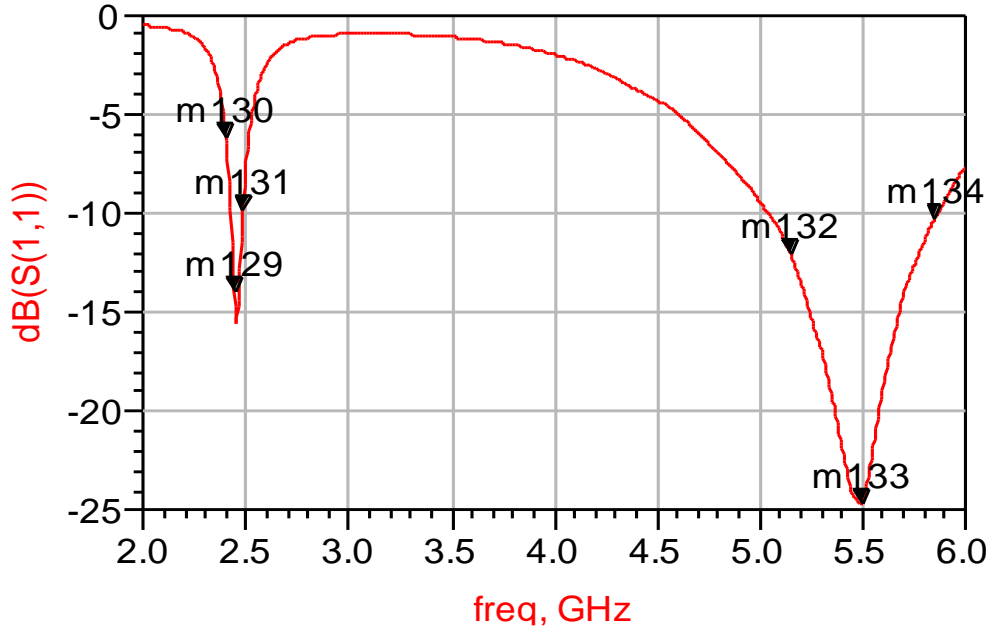

m130 freq=2.400GHz dB(S(1,1))=-6.202	m129 freq=2.442GHz dB(S(1,1))=-14.010	m131 freq=2.484GHz dB(S(1,1))=-9.880
m132 freq=5.150GHz dB(S(1,1))=-12.060	m133 freq=5.500GHz dB(S(1,1))=-24.657	m134 freq=5.850GHz dB(S(1,1))=-10.323

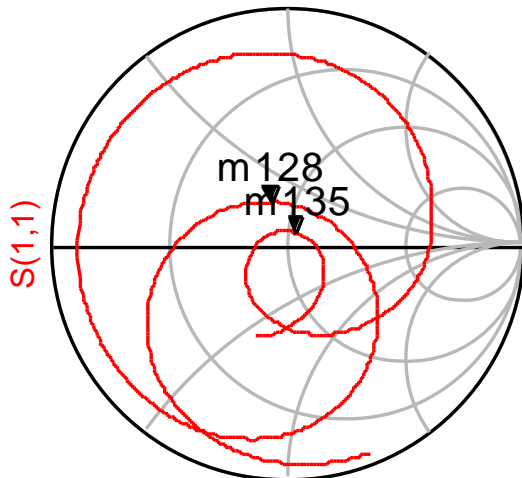

m128 freq=2.442GHz S(1,1)=0.199 / 110.889 impedance = 40.626 + j15.755
---

m135 freq=5.500GHz S(1,1)=0.059 / 59.150 impedance = 52.817 + j5.324
---

freq (2.000GHz to 6.000GHz)



**Evaluation Board Typical 2D Radiation Patterns (P/N 2450AD14A5500001CE2)**

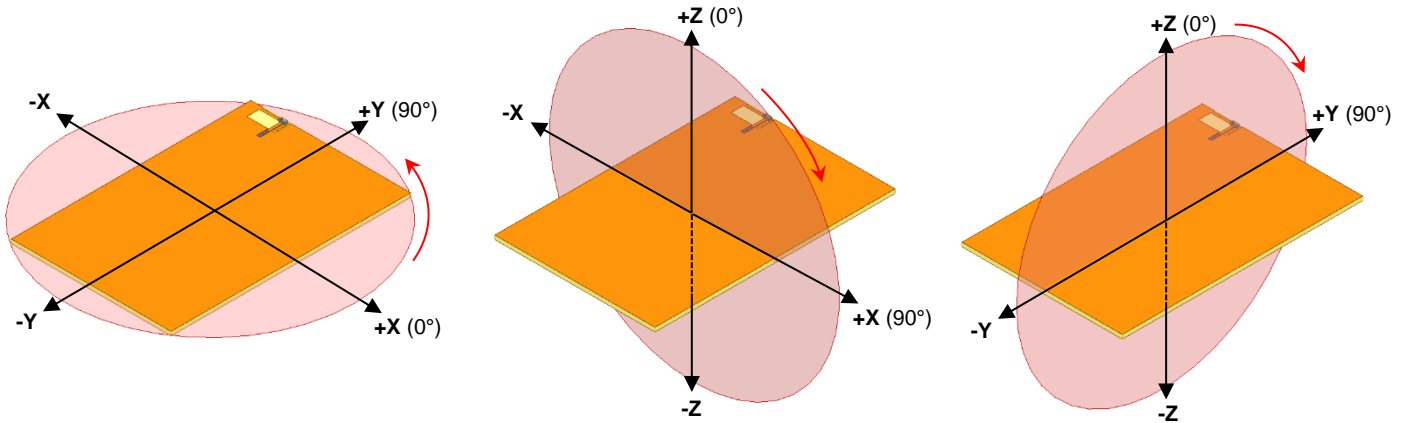

**@2.44GHz Band**

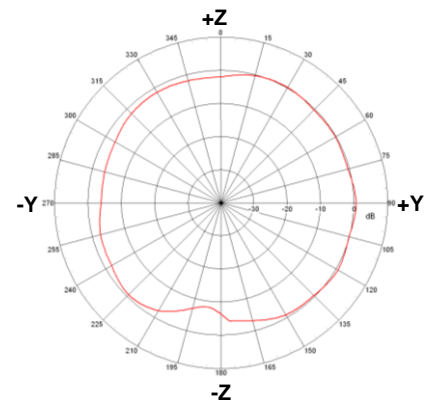
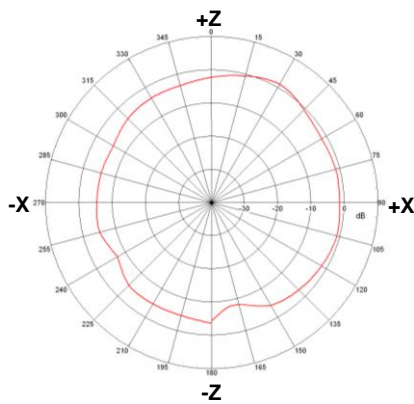
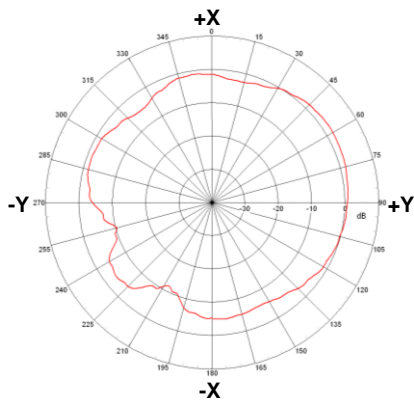

**@5.5GHz Band**

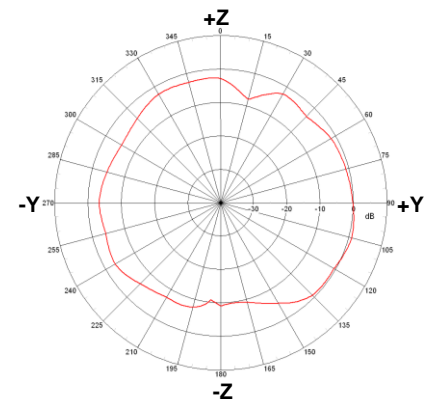
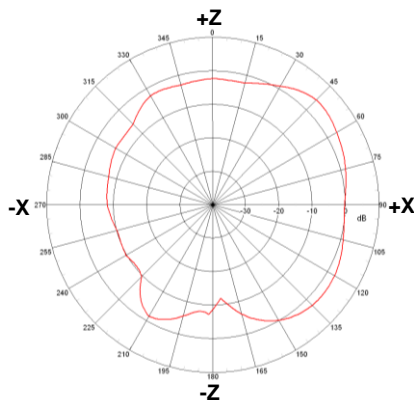
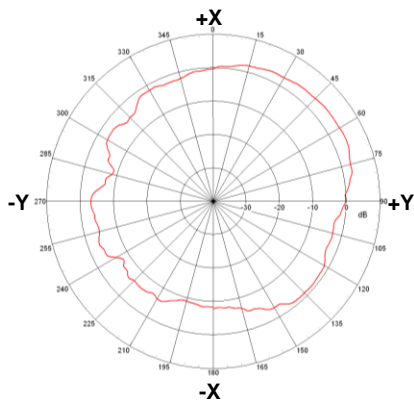

**Evaluation Board and Recommended Mounting Configuration 3 (For reference only, eval board non-orderable) – 70x40mm (Scenario 2 – “Left Feed”)**

All units in

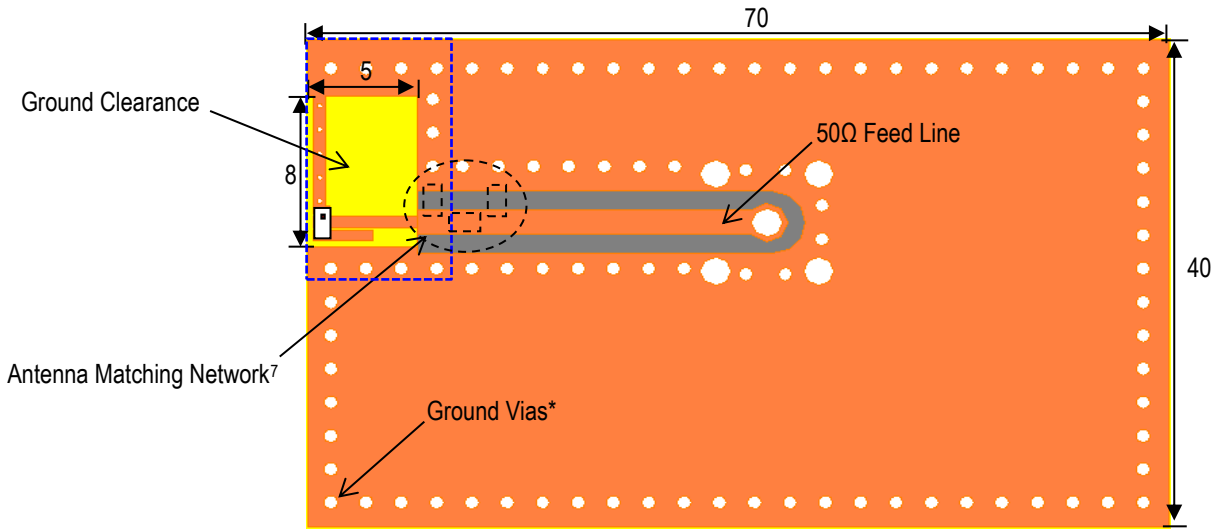

**Top View**

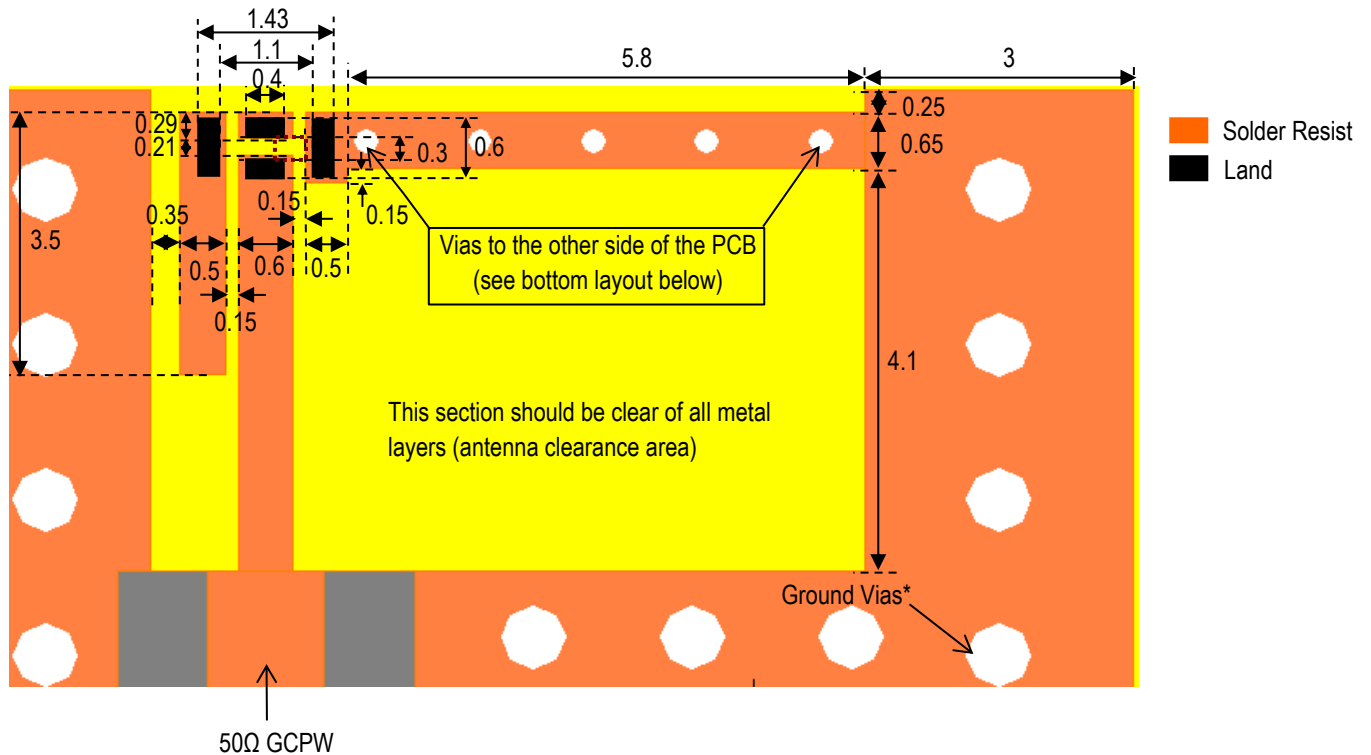

\*Note: Ground Vias are highly recommended to have better antenna efficiency.

<sup>7</sup> It is recommended that the designer leave available slots for a "pi" (or shunt-series-shunt) network. The antenna matching network values above are used when the antenna is mounted on Johanson's evaluation board. The optimal matching values will vary depending on the layout, thickness, material, etc. Go to: <https://www.johansontechnology.com/tuning> for more information.

**Bottom View**

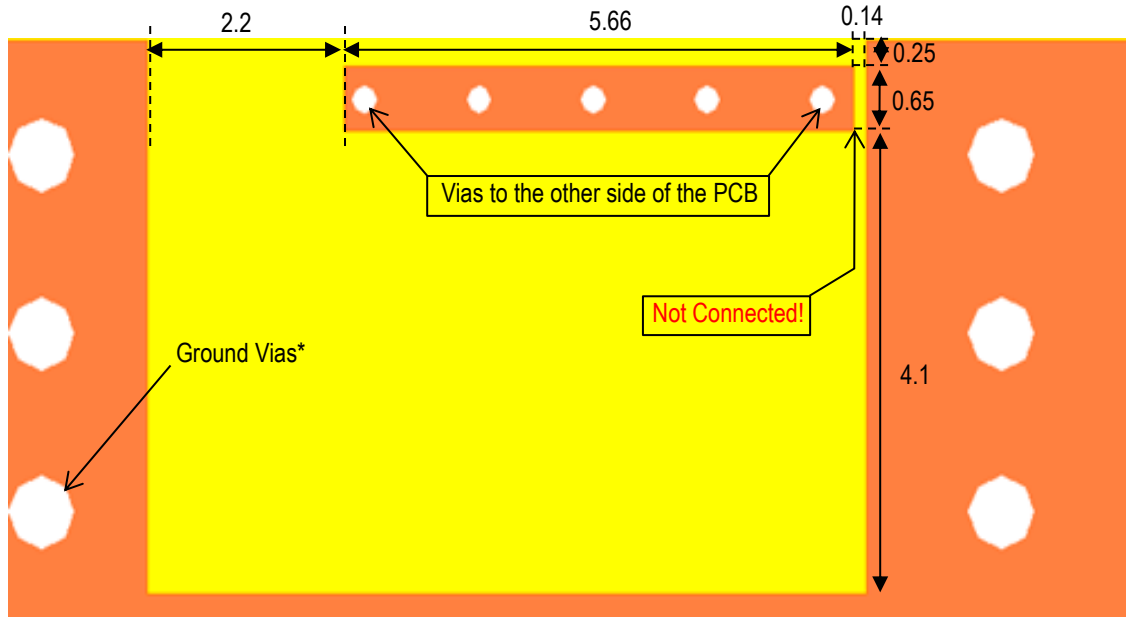

\*Note: Ground Vias are highly recommended to have better antenna efficiency.

If you'd like the CAD PCB layout or have any questions,  
contact our application engineers at <https://www.johansontechnology.com/ask-a-question>

What happens to the antenna's performance if you reduce the ground plane to **35x40mm LxW**? We'll share the study with you, send us a message at:  
<https://www.johansontechnology.com/ask-a-question>

**Recommended Single Feed Configuration with Diplexer Option**

If the single feed option is preferred, Johanson Technology has several chip diplexer options to both separate and filter the 2G and 5G signals. These diplexers are identical in size as the antenna itself and can be mounted just prior to the matching network of the antenna.

Pairing a 2.4GHz low pass filter with a 5.4GHz band pass filter not only separates the two signals but provides harmonic attenuation to fulfill regulation qualification for industry standards.

Example part numbers include 2450DP14C5400001T, 2450DP14D5400001T

For more information about our diplexers go to: <https://www.johansontechnology.com/diplexers>

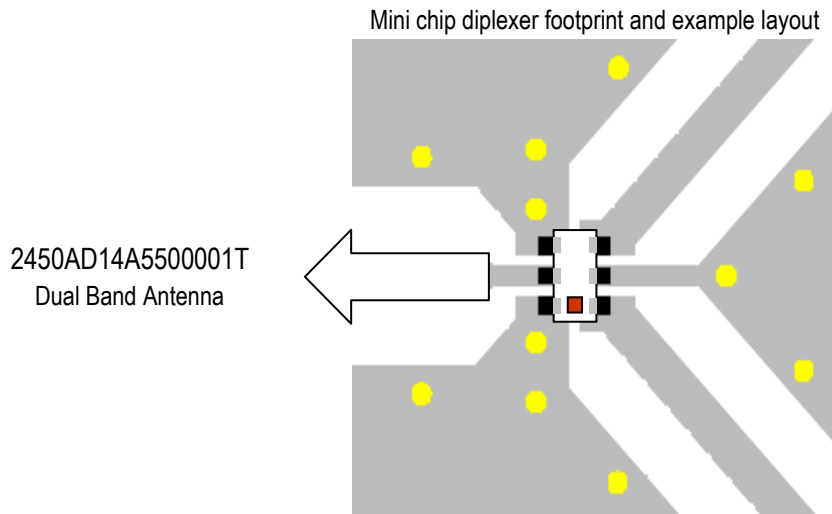

If you'd like the CAD PCB layout or have any questions, contact our application engineers at <https://www.johansontechnology.com/ask-a-question>

**Tape and Reel Specification (Units in mm)**

**Tape Dimensions**

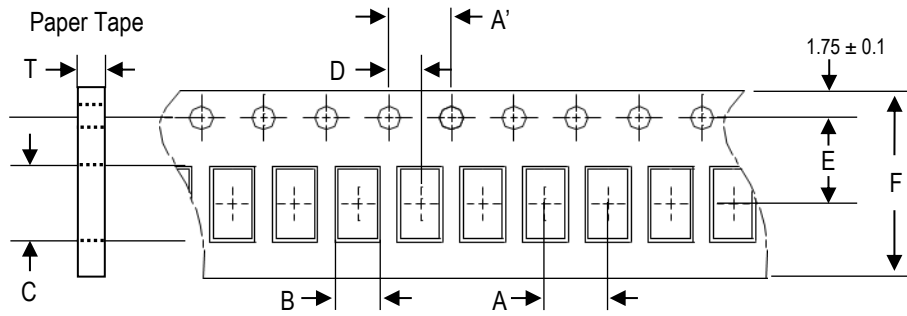

A	A'	B	C	D	E	F	T	Quantity/reel	Tape material
4.0±0.1	4.0±0.1	0.95±0.1	1.80±0.1	2.0±0.1	3.5±0.1	8.0±0.1	0.60±0.03	4,000pcs.	Paper

**Reel Dimensions**

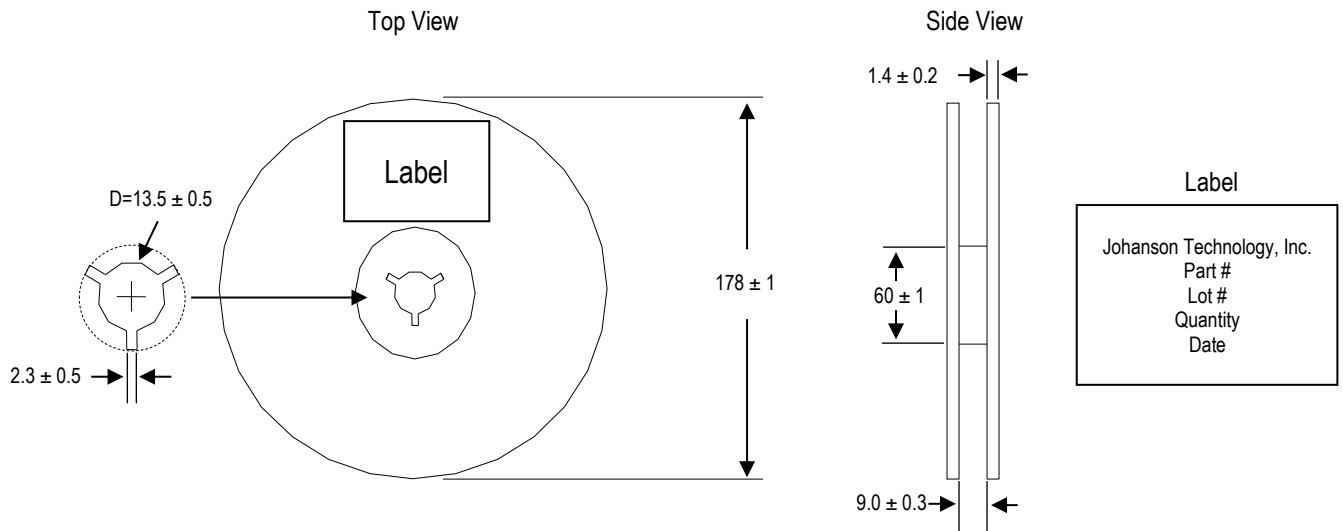

**Leader and Trailer Dimensions**

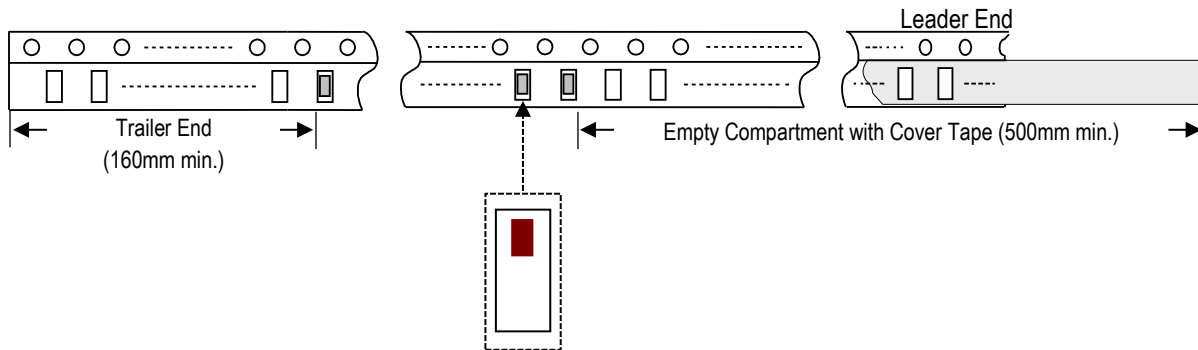

**Orderable Part Number**

Packaging Style	Part Number	Termination
Bulk (loose pcs.)	2450AD14A550001B	Nickel Tin
T & R (7" Reel Paper Tape)	2450AD14A550001T (Qty: 4,000 pcs./reel)	
Evaluation Board with 1 SMA Connector	2450AD14A550001CE1 (Page 3)	
	2450AD14A550001CE2 (Page 7)	

**Important Links**

[2450AD14A550001T Product Page](#)

[More RF Chip Antennas](#)

[Antenna Tuning, Optimization, and Validation Services](#)

[Soldering Information](#)

[MSL Information](#)

[Packaging Information](#)

[Recommended Storage Condition and Max Shelf Life](#)

[RoHS Compliance](#)

*Contact our application engineers for a PCB layout review.*

**Johanson Technology, Inc. reserves the right to make design changes without notice.  
All sales are subject to Johanson Technology, Inc. terms and conditions.**