

# High Frequency Ceramic Solutions

## 5.23GHz High Rejection UNII-low Band Pass Filter

P/N 5235BP44A0180

Detail Specification: 6/11/2019

Page 1 of 4

### General Specifications

Part Number	5235BP44A0180
Operating Frequency	5170 - 5330 MHz
Insertion loss (dB)	2.2 typ. (2.5 max.)
Return Loss (dB)	9.5 min.
Power Capacity (W)	3 max. (CW)
Reel Quantity (pcs/reel)	1,000
Operating Temperature	-40°C to +85°C
Recommended Storage Conditions for unused T&R product	+5 to +35°C Humidity 45~75%RH 18 months max.

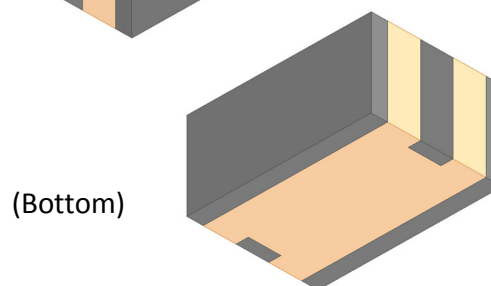
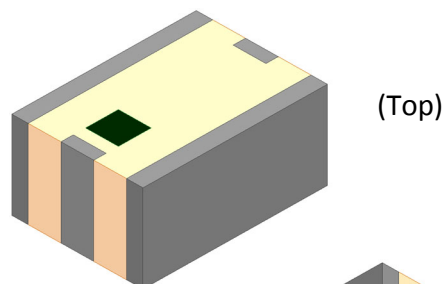

Attenuation (dB)	
2400 - 2500 MHz	34 typ. (30 min.)
5490 - 5835 MHz	42 typ. (40 min.)
10340 - 10660 MHz	28 typ. (25 min.)

You can download measured s-parameters of this component at: <https://www.johansontechnology.com/band-pass-filters>

### Part Number Explanation

P/N Suffix	Packaging Style	Bulk	Suffix = S	E.g. 5235BP44A0180S
		T & R	Suffix = E	E.g. 5235BP44A0180E
	Evaluation Board	50Ω SMA	Suffix = EB1SMA	E.g. 5235BP44A0180-EB1SMA

### Mechanical Dimensions

	In	mm
L	0.177 ± 0.008	4.50 ± 0.20
W	0.126 ± 0.008	3.20 ± 0.20
T	0.087 max.	2.20 max.
a	0.016 ± 0.008	0.40 ± 0.20
b	0.031 ± 0.008	0.80 ± 0.20
c	0.012 ± 0.006	0.30 ± 0.15

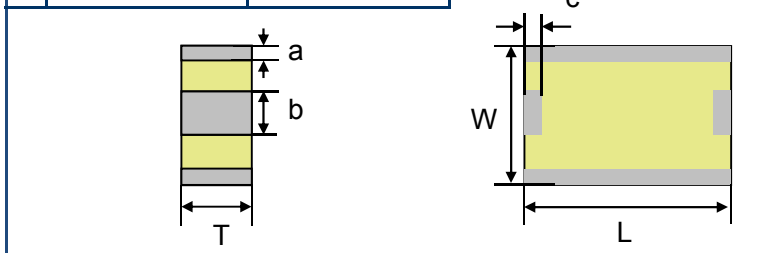

### Terminal Configuration

No.	Function
1	GND
2	INPUT / OUTPUT
3	GND
4	INPUT / OUTPUT

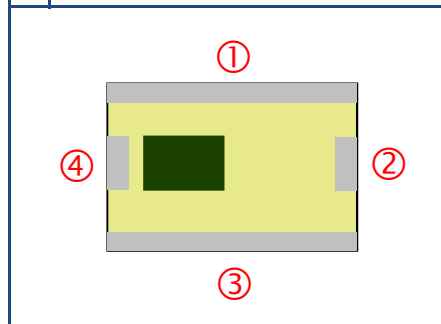

Johanson Technology, Inc. reserves the right to make design changes without notice.

All sales are subject to Johanson Technology, Inc. terms and conditions.



<https://www.johansontechnology.com>

4001 Calle Tecate • Camarillo, CA 93012, USA • TEL +1.805.389.1166

Ver. 1.1

2019 Johanson Technology, Inc. All Rights Reserved

# High Frequency Ceramic Solutions

5.23GHz High Rejection UNII-low Band Pass Filter

P/N 5235BP45A0180

Detail Specification: 6/11/2019

Page 2 of 4

## Mounting Pad Dimensions

units in mm

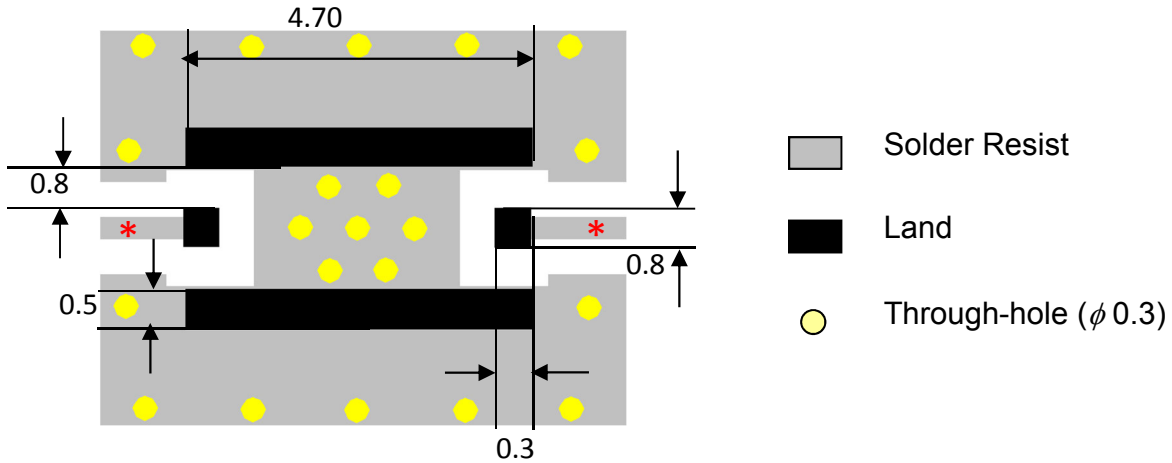

\*Transmission line width should be designed to match 50 $\Omega$  characteristic impedance, depending on PCB material and thickness.

Would you like the layout? Send us a message at: <https://www.johansontechnology.com/ask-a-question>

## Measurement Schematic

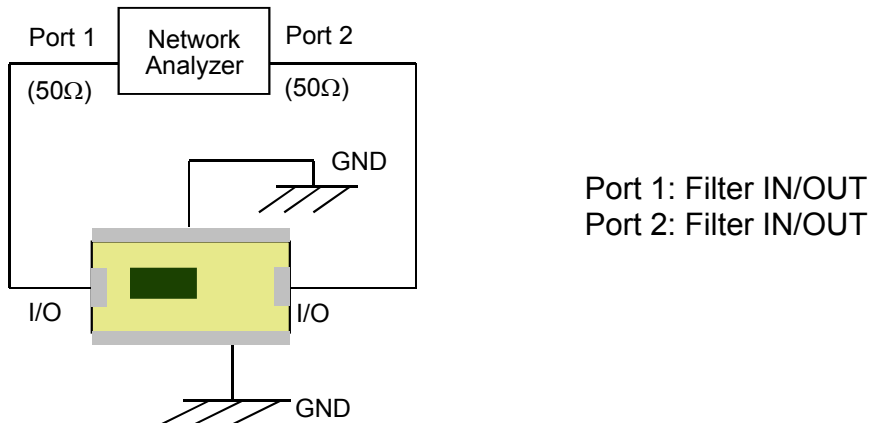

Johanson Technology, Inc. reserves the right to make design changes without notice.

All sales are subject to Johanson Technology, Inc. terms and conditions.



Ver. 1.1

<https://www.johansontechnology.com>

4001 Calle Tecate • Camarillo, CA 93012, USA • TEL +1.805.389.1166

2019 Johanson Technology, Inc. All Rights Reserved

# High Frequency Ceramic Solutions

5.23GHz High Rejection UNII-low Band Pass Filter

P/N 5235BP45A0180

Detail Specification: 6/11/2019

Page 3 of 4

## Typical Electrical Characteristics (T=25°C)

Insertion Loss & Return loss

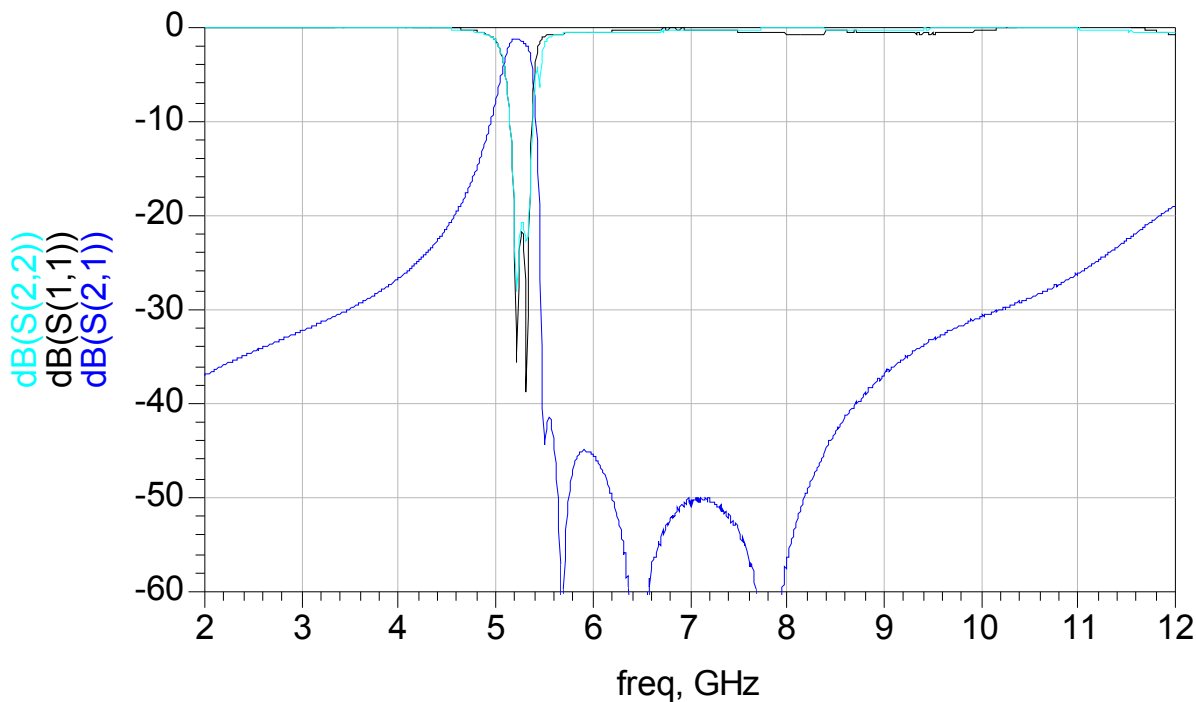

Do you need the S-parameter file of the above? Send us a message at:

<https://www.johansontechnology.com/ask-a-question>

Johanson Technology, Inc. reserves the right to make design changes without notice.

All sales are subject to Johanson Technology, Inc. terms and conditions.



Ver. 1.1

<https://www.johansontechnology.com>

4001 Calle Tecate • Camarillo, CA 93012, USA • TEL +1.805.389.1166

2019 Johanson Technology, Inc. All Rights Reserved

# High Frequency Ceramic Solutions

**5.23GHz High Rejection UNII-low Band Pass Filter**

**P/N 5235BP45A0180**

Detail Specification: 6/11/2019

Page 4 of 4

## Application Notes, Layout Files, and more

<https://www.johansontechnology.com/band-pass-filters>

## Packaging information

<https://www.johansontechnology.com/tape-reel-packaging>

## Soldering Information

<https://www.johansontechnology.com/ipcsoldering-profile>

## MSL Info

<https://www.johansontechnology.com/msl-rating>

## Recommended Storage Condition and Max Shelf Life

<https://www.johansontechnology.com/recommended-storage-conditions>

## RoHS Compliance

<https://www.johansontechnology.com/technical-notes/rohs-compliance>

## Antenna layout and tuning techniques

<https://www.johansontechnology.com/tuning.html>

## Antenna layout review, tuning, and characterization services

<https://www.johansontechnology.com/ipc-antenna-services>

Johanson Technology, Inc. reserves the right to make design changes without notice.

All sales are subject to Johanson Technology, Inc. terms and conditions.



Ver. 1.1

<https://www.johansontechnology.com>

4001 Calle Tecate • Camarillo, CA 93012, USA • TEL +1.805.389.1166

2019 Johanson Technology, Inc. All Rights Reserved