

## 7.22 GHz RF Chip Antenna

- 6.2 – 8.24 GHz Operational frequency
- UWB systems
- Mini SMD, EIA 0603
- Center-edge mount
- RoHS compliant

Johanson Technology, Inc. (JTI) miniature RF ceramic chip antennas are made using Low Temperature Co-fired Ceramic (LTCC) technology which has the ability to embed low and high dielectric constants inside our antenna. This enables our components to have high detuning resilience and stability over extreme temperatures (~2ppm).

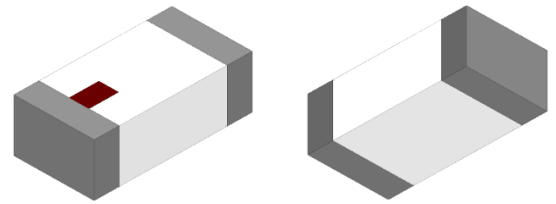

Recommended mounting locations for this antenna

PCB Center-edge



### General Specifications<sup>1 2</sup>

Operational Frequency (MHz)	6200 - 8240
Impedance ( $\Omega$ )	50
Return Loss (dB)	3.5 Min.
Peak Gain (dBi)	2.2 Typ.
Average Gain (dBi)	-1.8 Typ.
Average Radiated Efficiency (%)	72

### Maximum Ratings

Power Capacity (W)	3 Max. (CW)
Operating Temperature ( $^{\circ}\text{C}$ )	-40 to +85
Recommended Storage Conditions post-installation ( $^{\circ}\text{C}$ )	-40 to +85
Recommended Storage Conditions and Period for Unused T&R Product	45% - 75% RH +5 to +35 $^{\circ}\text{C}$ 18 Months Max.

<sup>1</sup> Typical value represents average measurement at 25 $^{\circ}\text{C}$ . Min./Max. values represent measurements over specified operating temperature.

<sup>2</sup> General specifications measured on Johanson's evaluation board P/N 7200AT14A2000001CE1.

**Mechanical Dimensions**

	Inches			Millimeters		
<b>L</b>	0.063	±	0.004	1.60	±	0.10
<b>W</b>	0.031	±	0.004	0.80	±	0.10
<b>T</b>	0.016	±	0.004	0.40	±	0.10
<b>a</b>	0.010	±	0.004	0.25	±	0.10

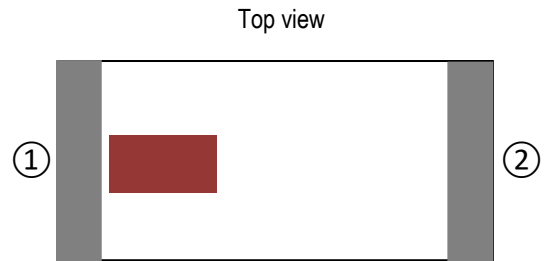
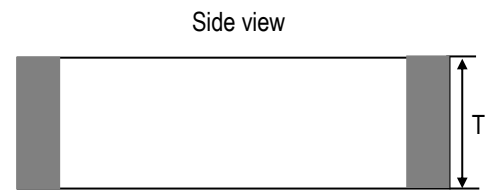
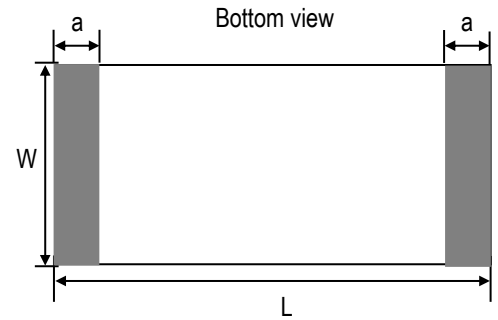

**Terminal Configuration<sup>3</sup>**

Pin Number	Function
1	Feed
2	Soldering Terminal

<sup>3</sup> The termination type is Nickel Tin. Go to: <https://www.johansontechnology.com/ipcsoldering-profile> for Typical Soldering Profile.

**Evaluation Board and Recommended Mounting Configuration (P/N 7200AT14A2000001CE1)**

All units in mm

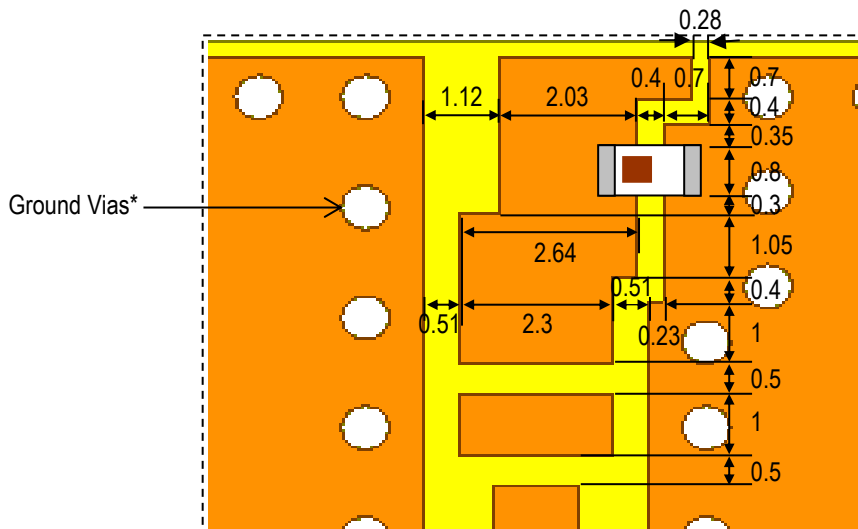
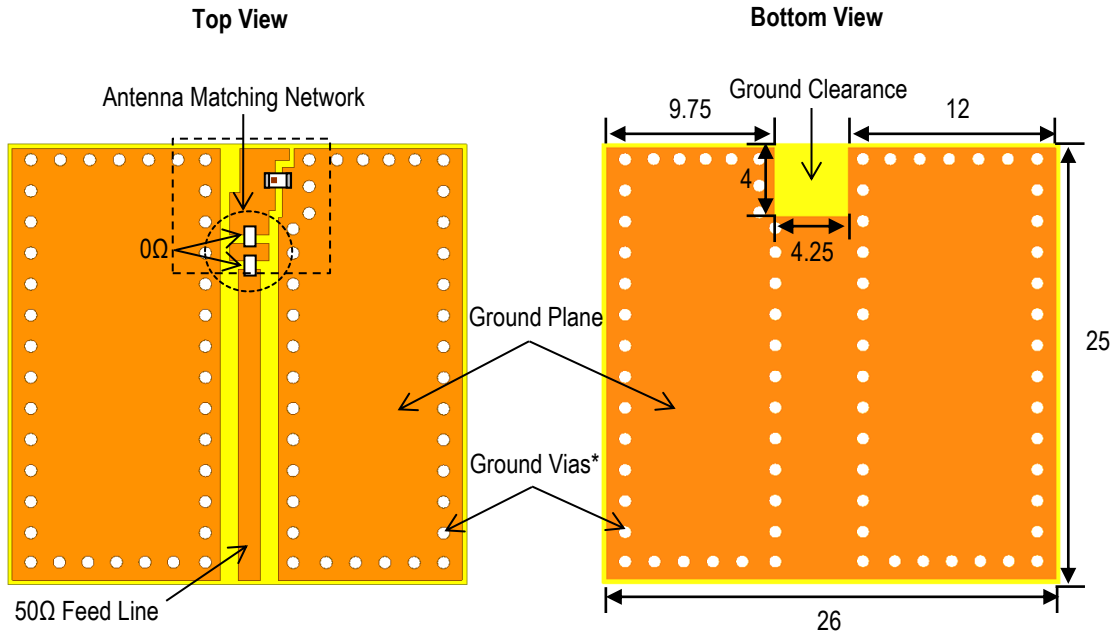

JTI P/N's for Matching Network<sup>4</sup>

N/A

\*Note: Ground Vias are highly recommended to have better antenna efficiency.

If you'd like the CAD PCB layout or have any questions,  
contact our application engineers at <https://www.johansontechnology.com/ask-a-question>

<sup>4</sup> It is recommended that the designer leave available slots for a "tee" (or series-shunt-series) network. The antenna matching network values above are used when antenna is mounted on Johanson's evaluation board. The matching values on client's PCB will be different, depending on the layout, thickness, material, etc. Go to: <https://www.johansontechnology.com/tuning> and see how to obtain the new values.

**Evaluation Board Typical Return Loss Measurement (P/N 7200AT14A2000001CE1)**

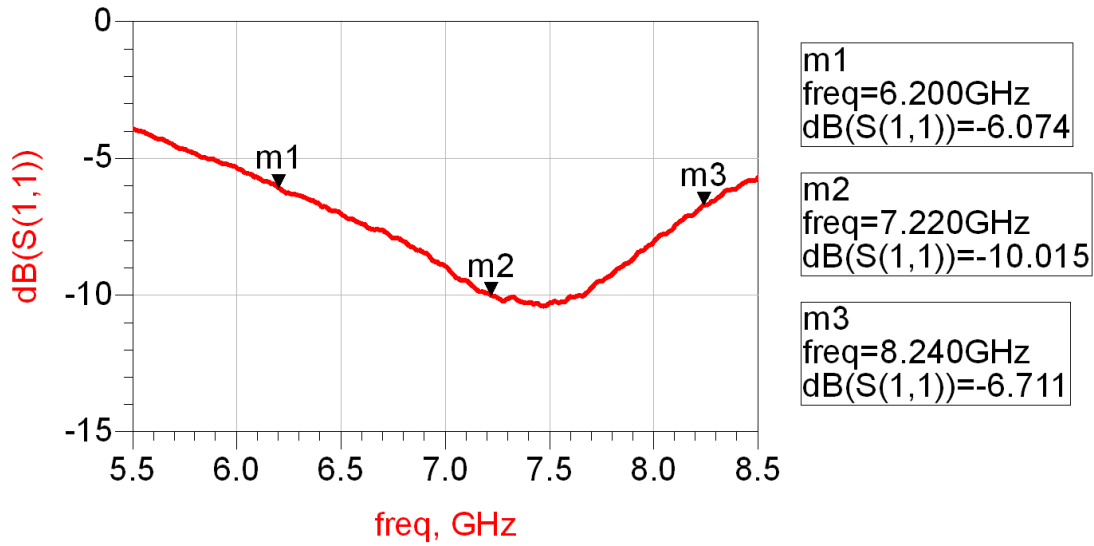

**Evaluation Board Typical 2D Radiation Patterns @7220 MHz (P/N 7200AT14A2000001CE1)**

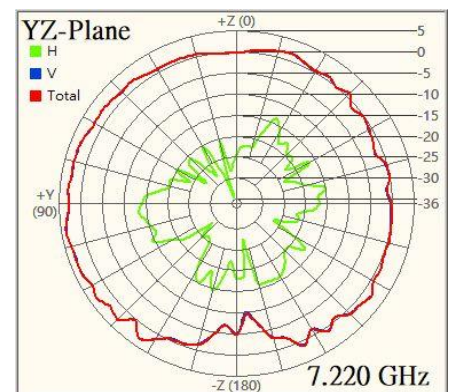
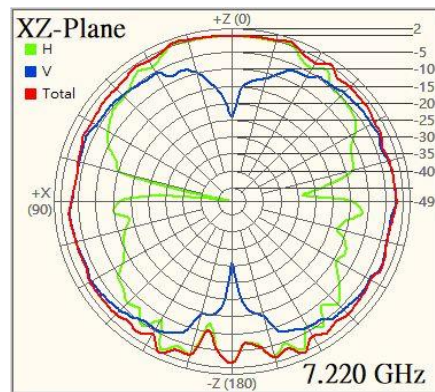
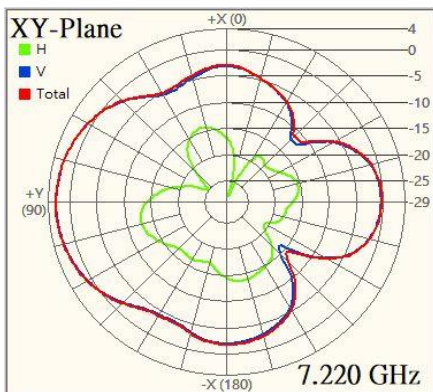
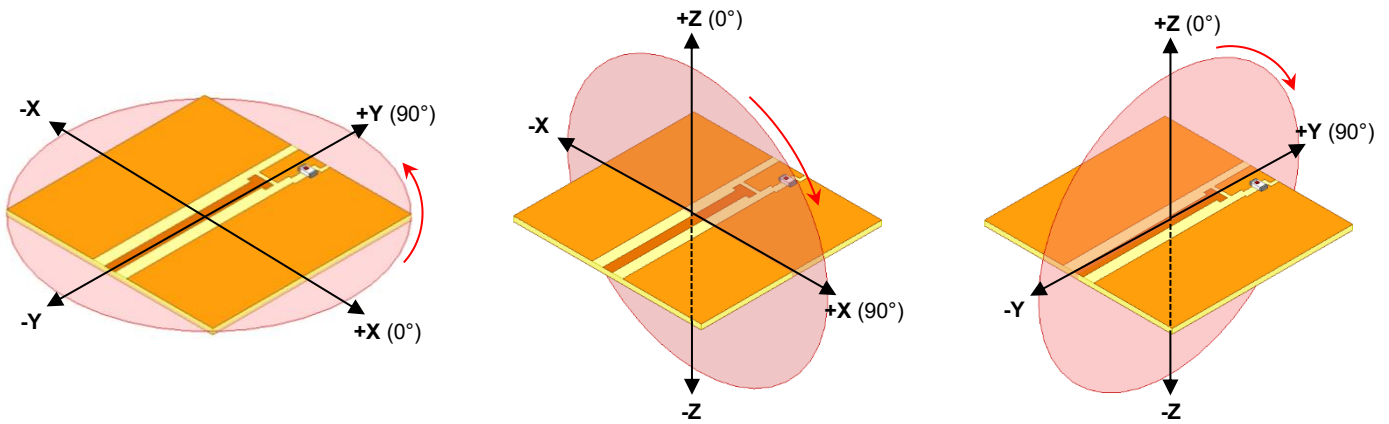

**Tape and Reel Specification (Units in mm)**

**Tape Dimensions**

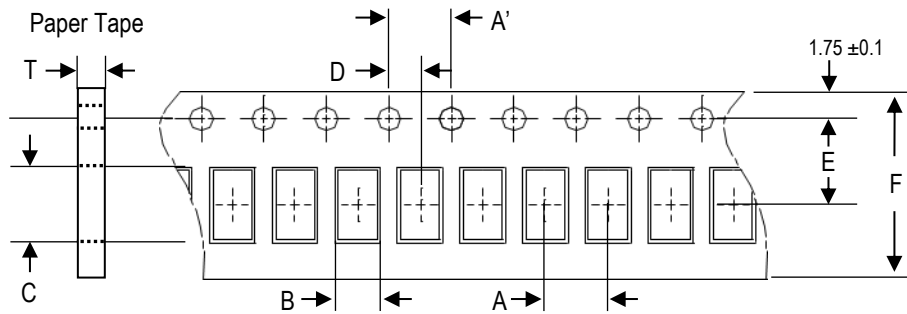

A	A'	B	C	D	E	F	T	Quantity/reel	Tape material
4.0 ±0.1	4.0 ±0.1	0.95 ±0.1	1.80 ±0.1	2.0 ±0.1	3.5 ±0.1	8.0 ±0.1	0.60 ±0.03	4,000pcs.	Paper

**Reel Dimensions**

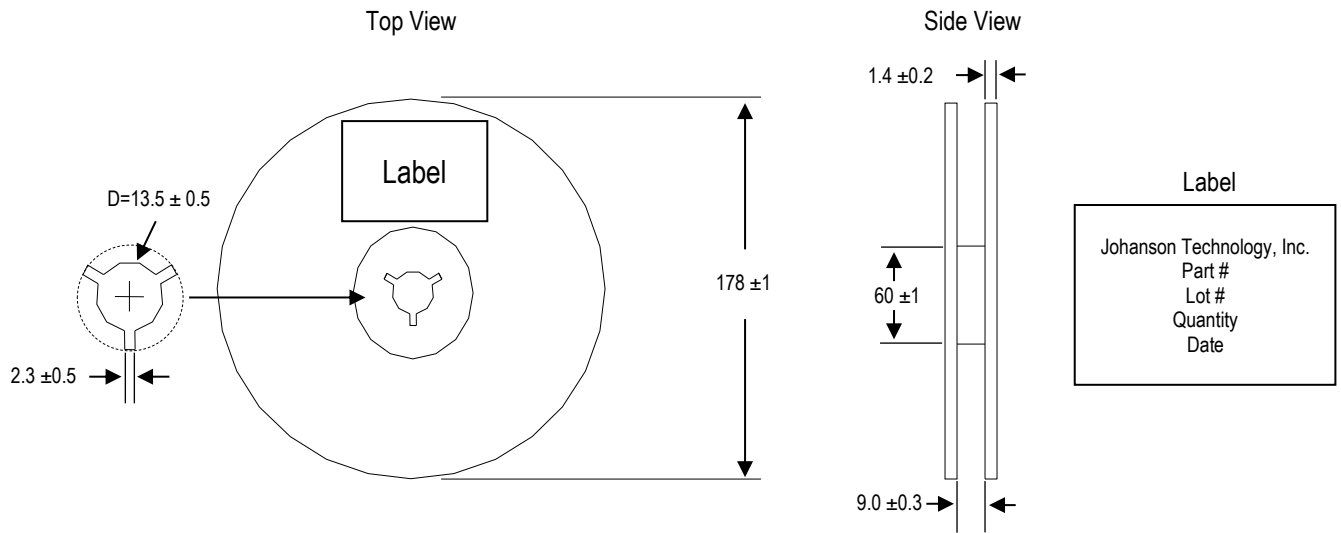

**Leader and Trailer Dimensions**

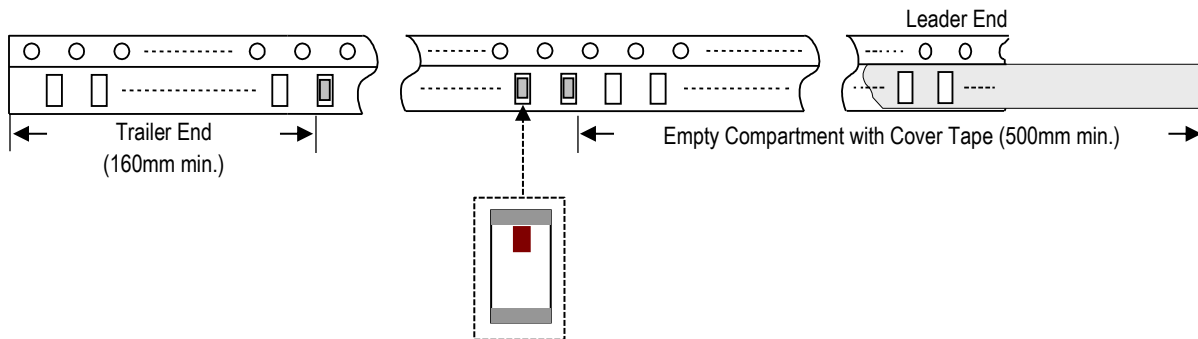

**Orderable Part Number**

Packaging Style	Part Number	Termination
Bulk (loose pcs.)	7200AT14A2000001B	Nickel Tin
T & R (7" Reel Paper Tape)	7200AT14A2000001T (Qty: 4,000 pcs./reel)	
Evaluation Board with 1 SMA Connector	7200AT14A2000001CE1	

**Important Links**

[7200AT14A2000001T Product Page](#)

[More RF Chip Antennas](#)

[Antenna Tuning, Optimization, and Validation Services](#)

[Soldering Information](#)

[MSL Information](#)

[Packaging Information](#)

[Recommended Storage Condition and Max Shelf Life](#)

[RoHS Compliance](#)

*Contact our application engineers for a PCB layout review.*

**Johanson Technology, Inc. reserves the right to make design changes without notice.  
All sales are subject to Johanson Technology, Inc. terms and conditions.**